



# Chunghwa Picture Tubes, Ltd. Technology Specification

To : 晶華微  
Date : 150127

**TFT LCD**  
**CLAA088WA01XN**

APPROVED BY	CHECKED BY	PREPARED BY
Ronald	Herman	Andy

Prepared by :  
Medium Product Planning Management General Division  
Product Planning Management Center  
**CHUNGHWA PICTURE TUBES, LTD.**

No 1 Huaying Rd., Sanho Tsun, Lungtan, Taoyuan, Taiwan 325, R.O.C.  
TEL: +886-3-480-5678 FAX: +886-3-260-7389

Doc.No:	SPEC_CLAA088WA01XN_0.4_晶華微_150127	Issue Date	2015/01/27
---------	-----------------------------------	------------	------------



# CONTENTS

<b>1. OVERVIEW</b> .....	<b>4</b>
<b>2. ABSOLUTE MAXIMUM RATINGS</b> .....	<b>5</b>
<b>3. ELECTRICAL CHARACTERISTICS</b> .....	<b>6</b>
3.1 TFT LCD .....	6
3.2 TFT-LCD Current Consumption.....	7
3.3 Power 、Signal sequence.....	7
3.4 Backlight.....	8
<b>4. INTERFACE CONNECTION</b> .....	<b>9</b>
4.1 CN1 (Input Signal).....	9
4.2 CN2 (LED backlight).....	11
<b>5. INPUT SIGNAL(DE ONLY MODE)</b> .....	<b>12</b>
5.1 Timing Specification.....	12
5.2 Timing sequence(Timing chart).....	12
5.2.1 Horizontal Timing Sequence .....	12
5.2.2 Vertical Timing Sequence .....	13
5.2.3 LVDS Input Data mapping.....	13
5.2.4 Color Data Reference.....	14
<b>6. MECHANICAL DIMENSION</b> .....	<b>15</b>
6.1 Front Side .....	15
6.2 Rear Side .....	16
<b>7. OPTICAL CHARACTERISTICS</b> .....	<b>17</b>
<b>8. RELIABILITY TEST</b> .....	<b>19</b>
8.1. Temperature and humidity.....	19
8.2. Shock and Vibration.....	19
8.4. Judgment standard .....	19
<b>9. WARRANTY</b> .....	<b>20</b>

## 1. OVERVIEW

**CLAA088WA01XN** is 8.8" color TFT-LCD (Thin Film Transistor Liquid Crystal Display) module composed of LCD panel, driver ICs ,control circuit and LED backlight. By applying 1280x480 images are displayed on the 8.8" diagonal screen. Display 16.7M colors by R.G.B signal input.

General specification are summarized in the following table:

ITEM	SPECIFICATION			
Display Area (mm)	209.28(W) x 78.48(H)			
Number of Pixels	1280(H) x 3 (RGB) x 480(V)			
Pixel Pitch (mm)	0.1635(W) x 0.1635(H)			
Color Pixel Arrangement	RGB vertical stripe			
Display Mode	Normally black			
Number of Colors	16.7M			
Brightness (cd/m <sup>2</sup> )	400 (Min.)/500 (Typ.)			
Response Time (ms)	25ms(Typ.)			
Optimum Viewing Direction	Full			
Contrast Ratio	1000:1(Typ.)/ 600:1(min)			
Viewing Angle ( CR ≥ 10)	170degree (Horizontal.)			
	170degree (Vertical)			
Power Consumption (W)	3.22 W(Typ)			
Interface connection	LVDS			
Module Size (mm)		Min.	Typ.	Max.
	Horizontal(H)	229.3	229.6	229.9
	Vertical(V)	97	97.3	97.6
	Depth(D) (w/o FPC )	5.7	6	6.3
Module Weight (g)	(215)g			
Backlight Unit	LED			
Surface Treatment	AG 25%			

## 2. ABSOLUTE MAXIMUM RATINGS

The following are maximum values which, if exceeded, may cause faulty operation or damage to the unit.

Item	Symbol	Min.	Max.	Unit	Note
Digital Supply Voltage	DVDD DVDD_LVDS	-0.3	5	V	
Analog Supply Voltage	AVDD	-0.5	15	V	
Gate On Voltage	VGH	-0.3	VGL+44	V	
Gate Off Voltage	VGL	VGH-44	0.3	V	
Gate On-Gate Off Voltage	VGH-VGL	VGL-0.3	VGG+0.3	V	
Signal Input Voltage	NIND0 ~ NIND3 PIND0 ~ PIND3 NINC,PINC	-0.3	DVDD+0.3	V	
Forward Current (per LED)	I <sub>f</sub>	-	80	mA	
Pulse forward current (per LED)	I <sub>fp</sub>	-	200	mA	1、2、3
Operating temperature	T <sub>opa</sub>	-20	70	°C	4
Storage temperature	T <sub>stg</sub>	-30	80	°C	4

Note :

- \*1) If the product were used out of the operation and storage range, it will have quality issue.
- \*2) I<sub>fp</sub> Conditions : Pulse Width ≤ 10msec · Duty ≤ 1/10.
- \*3) Each one of LED operation must be follow diagram of Ambient Temperature and Allowable Forward Current.

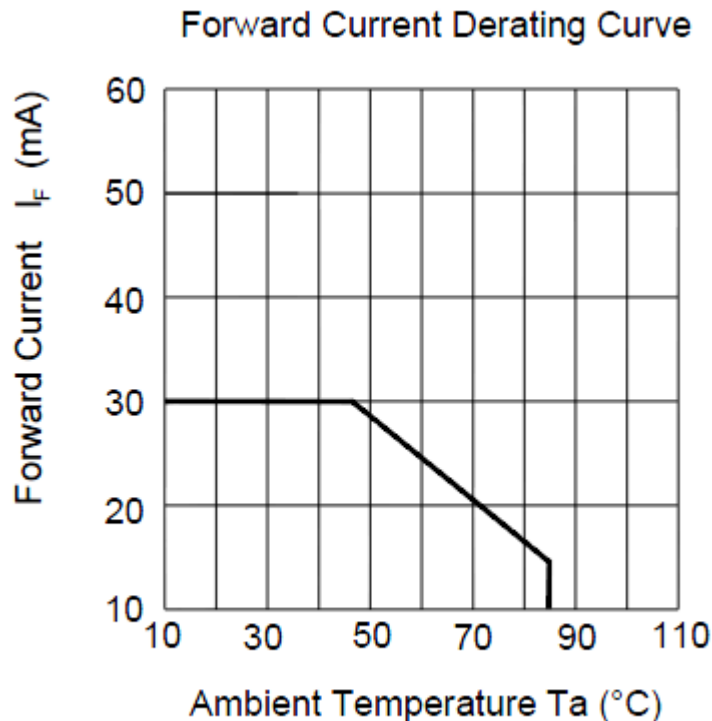

- \*4) If users use the product out off the environmental operation range ( temperature and humidity ) , it will have visual quality concerns.

### 3. ELECTRICAL CHARACTERISTICS

#### 3.1 TFT LCD

Ta=25°C

ITEM	SYMBOL	MIN	TYP	MAX	UNIT	NOTE
Digital Power Supply Voltage For LCD	DVDD VDD_LVDS	3	3.3	3.6	V	
Logic Input Voltage (LVDS:IN+,IN-)	VCM	$\frac{ VID }{2}$	-	DVDD-1.2	V	Note1
	VID	200	-	600	mV	Note1
	VTH	-	-	100	mV	VCM=1.2V Note1
	VTL	-100	-	-	mV	
Analog Power Supply Voltage	AVDD	12.8	13	13.2	V	
Gate On Power Supply Voltage	VGH	19	20	21	V	
Gate Off Power Supply Voltage	VGL	-6.6	-6	-5.4	V	
Logic Input Voltage	VIH	0.7*DVDD	-	DVDD	V	
	VIL	GND	-	0.3*DVDD	V	
Gamma Voltage	V1	-	12.29	-	V	Note2
	V2	-	10.38	-	V	
	V3	-	9.79	-	V	
	V4	-	9.09	-	V	
	V5	-	8.49	-	V	
	V6	-	8.01	-	V	
	V7	-	6.96	-	V	
	V8	-	6.04	-	V	
	V9	-	4.99	-	V	
	V10	-	4.51	-	V	
	V11	-	3.92	-	V	
	V12	-	3.21	-	V	
	V13	-	2.62	-	V	
	V14	-	0.71	-	V	

【Note1】 LVDS signal

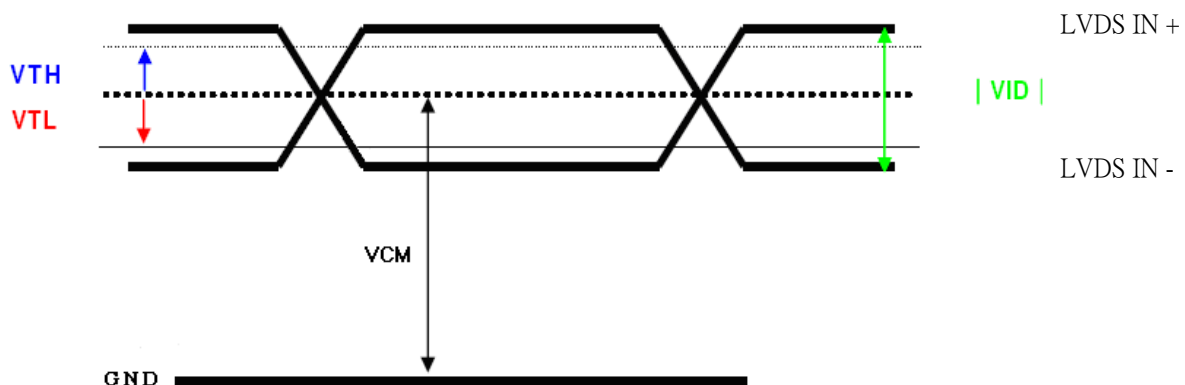

【Note2】 (1)Gamma voltage is the reference voltage for customer, it could be adjust by customer.

(2)The voltage of these pins must be:

$$V1 > V2 > V3 > V4 > V5 > V6 > V7 > V8 > V9 > V10 > V11 > V12 > V13 > V14$$

$$AVDD - 0.1 > V1 \sim V7 > 0.4AVDD ; 0.6AVDD > V8 \sim V14 > AGND + 0.1$$

【Recommend】 VCOM must be optimized according to each LCM. Please adjust VR to make the flicker level be minimum for getting excellent image.

### 3.2 TFT-LCD Current Consumption

Item	Symbol	Condition	Min.	Typ.	Max.	Unit.	Note.
Gate on Current	IVGH	VGH = 20V	-	0.5	1	mA	【Note1】
Gate off Current	IVGL	VGL = -6V	-	0.5	1	mA	【Note1】
Digital Current	IDVDD	DVDD = 3.3V	-	25	35	mA	【Note1】
Analog Current	IAVDD	AVDD = 13V	-	30	60	mA	【Note1】
Total Power Consumption	PC		-	485.5	921.5	mW	【Note1】

Note1: Typical: Under 256 gray pattern  
 Maximum: Under white pattern



256 gray pattern



White Pattern

### 3.3 Power · Signal sequence

Power On : DVDD → AVDD/VGL → VGH → Video & Logic Signal → Backlight  
 Power Off : Backlight → Video & Logic Signal → VGH → AVDD/VGL → DVDD

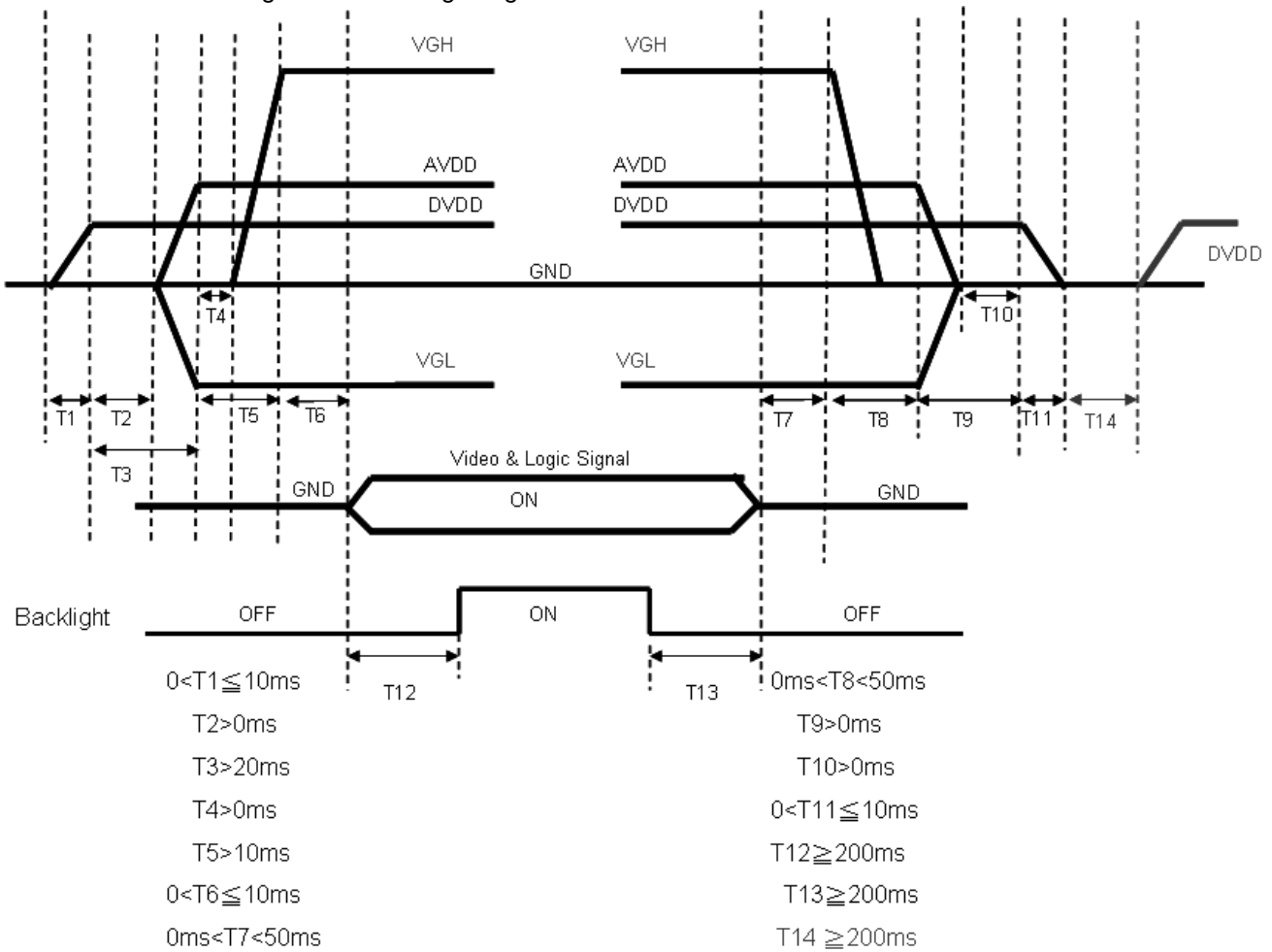

3.4 Backlight

Ta=25°C

ITEM	SYMBOL	CONDITIONS	MIN	TYP	MAX	UNIT	NOTE
LED current	IL	Ta=25°C (20mA/serise)	--	280	--	mA	
LED voltage	VL	Ta=25°C (20mA/serise)	8.55	9.75	10.8	V	
Power consumption	WL	Ta=25°C (20mA/serise)	--	2.73	--	W	
LED Lifetime	-	Ta=60°C IF=20mA	30000			Hr	

Remarks :

\*1)LED Circuit Diagram

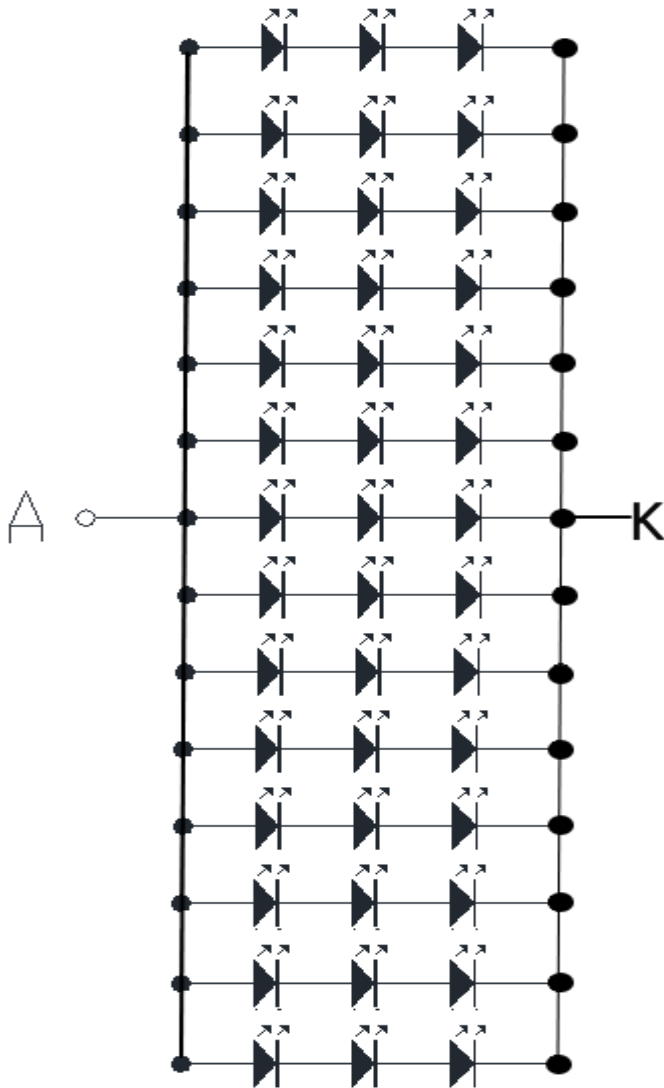

\*2) A : Anode(+) , K : Cathode(-)

\*3) Suggestion: Using the constant current control to avoid the leakage light and brightness quality issue.

\*4) Definition of Led lifetime : Luminance < Initial luminance 50%.



## 4. INTERFACE CONNECTION

### 4.1 CN1 (Input Signal)

PIN NO	SYMBOL	DESCRIPTION
1	AGND	Analog ground
2	AVDD	Analog power
3	DVDD	Digital power
4	GND	Digital ground
5	NC	Not connect
6	DVDD	Digital power
7	GND	Digital ground
8	V14	Gamma correction voltage reference
9	V13	Gamma correction voltage reference
10	V12	Gamma correction voltage reference
11	V11	Gamma correction voltage reference
12	V10	Gamma correction voltage reference
13	V9	Gamma correction voltage reference
14	V8	Gamma correction voltage reference
15	GND	Digital ground
16	DVDD_LVDS	LVDS power
17	GND	Digital ground
18	PIND3	Positive LVDS differential data input
19	NIND3	Negative LVDS differential data input
20	GND	Digital ground
21	PINC	Positive LVDS differential clock input
22	NINC	Negative LVDS differential clock input
23	GND	Digital ground
24	PIND2	Positive LVDS differential data input
25	NIND2	Negative LVDS differential data input
26	GND	Digital ground
27	PIND1	Positive LVDS differential data input
28	NIND1	Negative LVDS differential data input
29	GND	Digital ground
30	PIND0	Positive LVDS differential data input
31	NIND0	Negative LVDS differential data input
32	GND	Digital ground
33	GND_LVDS	LVDS ground
34	GRB	Global reset pin. Active low to enter reset state. Suggest to connecting with an RC reset circuit for stability. Normally pull high. (R=47KΩ · C=0.1μF)
35	STBYB	Standby mode, normally pull high STBYB="1", normal operation STBYB="0", timing control, source driver will turn off, all output are high-Z
36	SHLR	Left or right display control
37	DVDD	Digital power
38	UPDN	Up / down display control
39	AGND	Analog ground
40	AVDD	Analog power
41	NC	Not connect

42	NC	Not connect
43	GND	Digital ground
44	DVDD	Digital Power
45	GND	Digital ground
46	V7	Gamma correction voltage reference
47	V6	Gamma correction voltage reference
48	V5	Gamma correction voltage reference
49	V4	Gamma correction voltage reference
50	V3	Gamma correction voltage reference
51	V2	Gamma correction voltage reference
52	V1	Gamma correction voltage reference
53	GND	Digital ground
54	DVDD	Digital power
55	SELB	6bit/8bit mode select, SELB = "1", LVDS input data is 8bits SELB = "0", LVDS input data is 6bits
56	VGH	Positive power for TFT
57	DVDD	Digital power for Gate IC
58	VGL	Negative power for TFT
59	GND	Digital ground for Gate IC
60	NC	Not connect

Remarks : Mating connector : 089K60-000100-G2-R (STARCONN)

Note 1 : UPDN and SHLR control function

SHLR	UPDN	Data shifting
DVDD	GND	Left→Right , Up→Down(default)
GND	GND	Right→Left , Up→Down
DVDD	DVDD	Left→Right , Down→Up
GND	DVDD	Right→Left , Down→Up

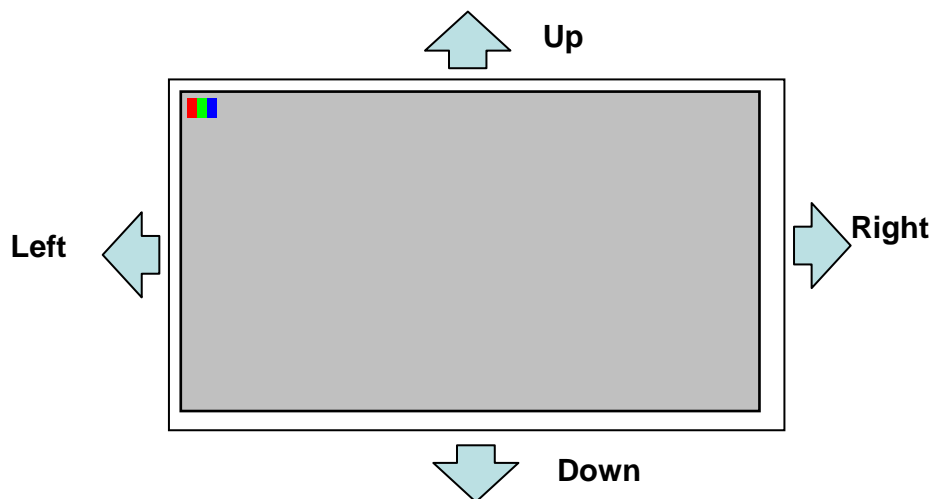

## 4.2 CN2 (LED backlight)

Pin No.	Symbol	Function	Remark
1	+	positive pole	BLACK
2	-	negative pole	WHITE

Input connector : BHSR-02VS-1(JST)

Outlet connector: SM02B-BHSS-1(JST)

## 5. INPUT SIGNAL(DE ONLY MODE)

### 5.1 Timing Specification

Item		Symbol	Min.	Typ.	Max.	Unit	
LVDS input signal sequence	CLK Frequency	tclk	42	45	60	MHz	
LCD input signal sequence (Input LVDS Transmitter)	Horizontal	Horizontal total Time	$t_H$	1373	1413	1488	tCLK
		Horizontal effective Time	$t_{HA}$	1280			tCLK
		Horizontal Blank Time	$t_{HB}$	93	133	208	tCLK
	Vertical	Vertical total Time	$t_V$	517	533	672	$t_H$
		Vertical effective Time	$t_{VA}$	480			$t_H$
		Vertical Blank Time	$t_{VB}$	37	53	192	$t_H$

### 5.2 Timing sequence(Timing chart)

#### 5.2.1 Horizontal Timing Sequence

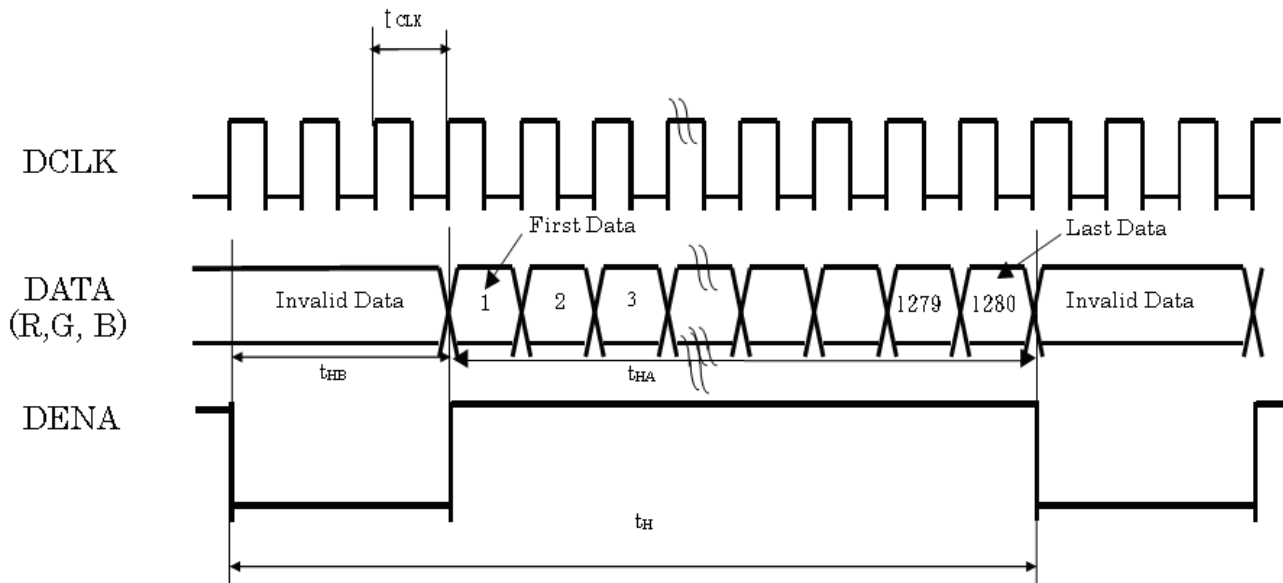

5.2.2 Vertical Timing Sequence

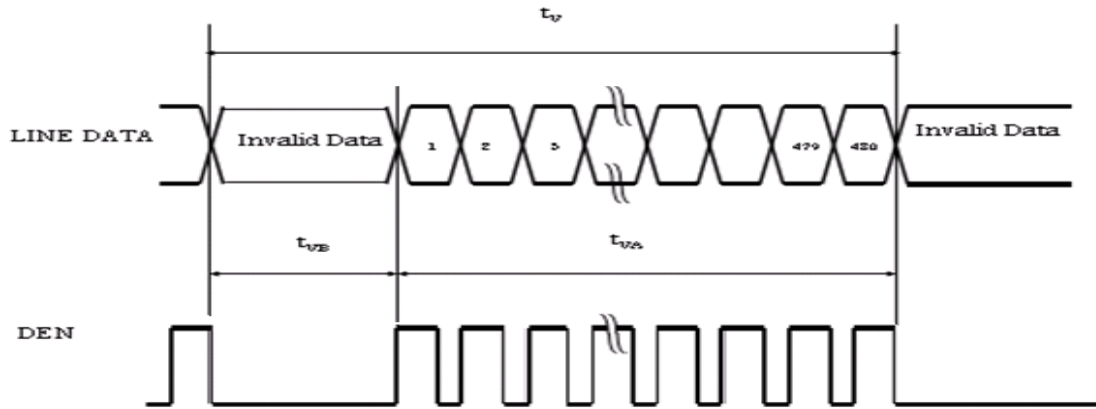

5.2.3 LVDS Input Data mapping  
6 Bit LVDS input

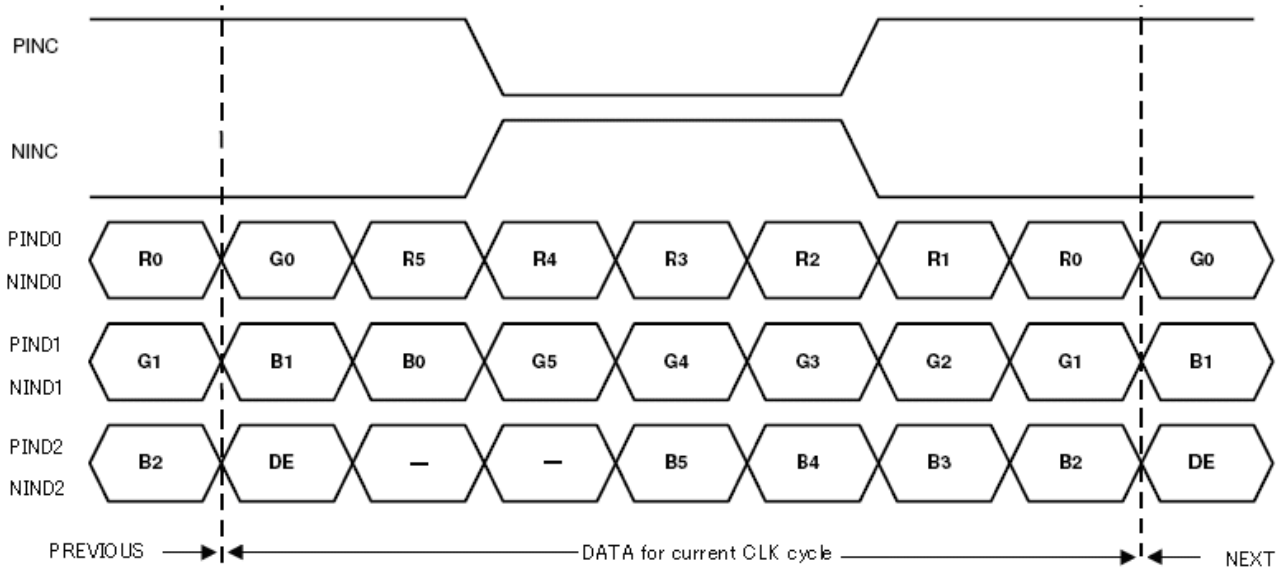

8 Bit LVDS input

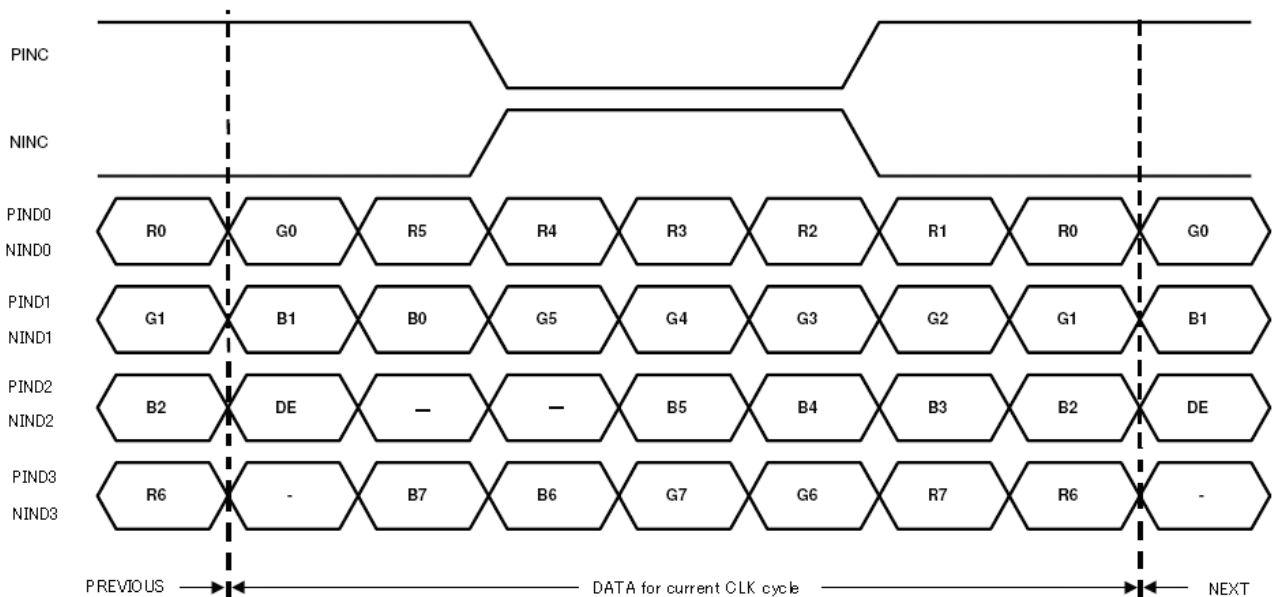

5.2.4 Color Data Reference

COLOR	INPUT DATA	R DATA								G DATA								B DATA							
		R7	R6	R5	R4	R3	R2	R1	R0	G7	G6	G5	G4	G3	G2	G1	G0	B7	B6	B5	B4	B3	B2	B1	B0
		MSB							LSB	MSB							LSB	MSB							LSB
BASIC COLOR	BLACK	0	0	0	0	0	0	0	0	0	0	0	0	0	0	0	0	0	0	0	0	0	0	0	0
	RED(255)	1	1	1	1	1	1	1	1	0	0	0	0	0	0	0	0	0	0	0	0	0	0	0	0
	GREEN(255)	0	0	0	0	0	0	0	0	1	1	1	1	1	1	1	1	0	0	0	0	0	0	0	0
	BLUE(255)	0	0	0	0	0	0	0	0	0	0	0	0	0	0	0	0	1	1	1	1	1	1	1	1
	CYAN	0	0	0	0	0	0	0	0	1	1	1	1	1	1	1	1	1	1	1	1	1	1	1	1
	MAGENTA	1	1	1	1	1	1	1	1	0	0	0	0	0	0	0	0	1	1	1	1	1	1	1	1
	YELLOW	1	1	1	1	1	1	1	1	1	1	1	1	1	1	1	1	0	0	0	0	0	0	0	0
	WHITE	1	1	1	1	1	1	1	1	1	1	1	1	1	1	1	1	1	1	1	1	1	1	1	1
RED	RED(0)	0	0	0	0	0	0	0	0	0	0	0	0	0	0	0	0	0	0	0	0	0	0	0	0
	RED(1)	0	0	0	0	0	0	0	1	0	0	0	0	0	0	0	0	0	0	0	0	0	0	0	0
	RED(2)	0	0	0	0	0	0	1	0	0	0	0	0	0	0	0	0	0	0	0	0	0	0	0	0
	RED(254)	1	1	1	1	1	1	1	0	0	0	0	0	0	0	0	0	0	0	0	0	0	0	0	0
	RED(255)	1	1	1	1	1	1	1	1	0	0	0	0	0	0	0	0	0	0	0	0	0	0	0	0
GREEN	GREEN(0)	0	0	0	0	0	0	0	0	0	0	0	0	0	0	0	0	0	0	0	0	0	0	0	0
	GREEN(1)	0	0	0	0	0	0	0	0	0	0	0	0	0	0	1	0	0	0	0	0	0	0	0	0
	GREEN(2)	0	0	0	0	0	0	0	0	0	0	0	0	0	0	1	0	0	0	0	0	0	0	0	0
	GREEN(254)	0	0	0	0	0	0	0	0	1	1	1	1	1	1	1	0	0	0	0	0	0	0	0	0
	GREEN(255)	0	0	0	0	0	0	0	0	1	1	1	1	1	1	1	1	0	0	0	0	0	0	0	0
BLUE	BLUE(0)	0	0	0	0	0	0	0	0	0	0	0	0	0	0	0	0	0	0	0	0	0	0	0	0
	BLUE(1)	0	0	0	0	0	0	0	0	0	0	0	0	0	0	0	0	0	0	0	0	0	0	0	1
	BLUE(2)	0	0	0	0	0	0	0	0	0	0	0	0	0	0	0	0	0	0	0	0	0	0	1	0
	BLUE(254)	0	0	0	0	0	0	0	0	0	0	0	0	0	0	0	0	1	1	1	1	1	1	1	0
	BLUE(255)	0	0	0	0	0	0	0	0	0	0	0	0	0	0	0	0	1	1	1	1	1	1	1	1

【Note】

- 1) Gray level:  
Color(n) : n is level order; higher n means brighter level.
- 2) DATA:  
1: high , 0: low

### 6. MECHANICAL DIMENSION

#### 6.1 Front Side

[Unit : mm]

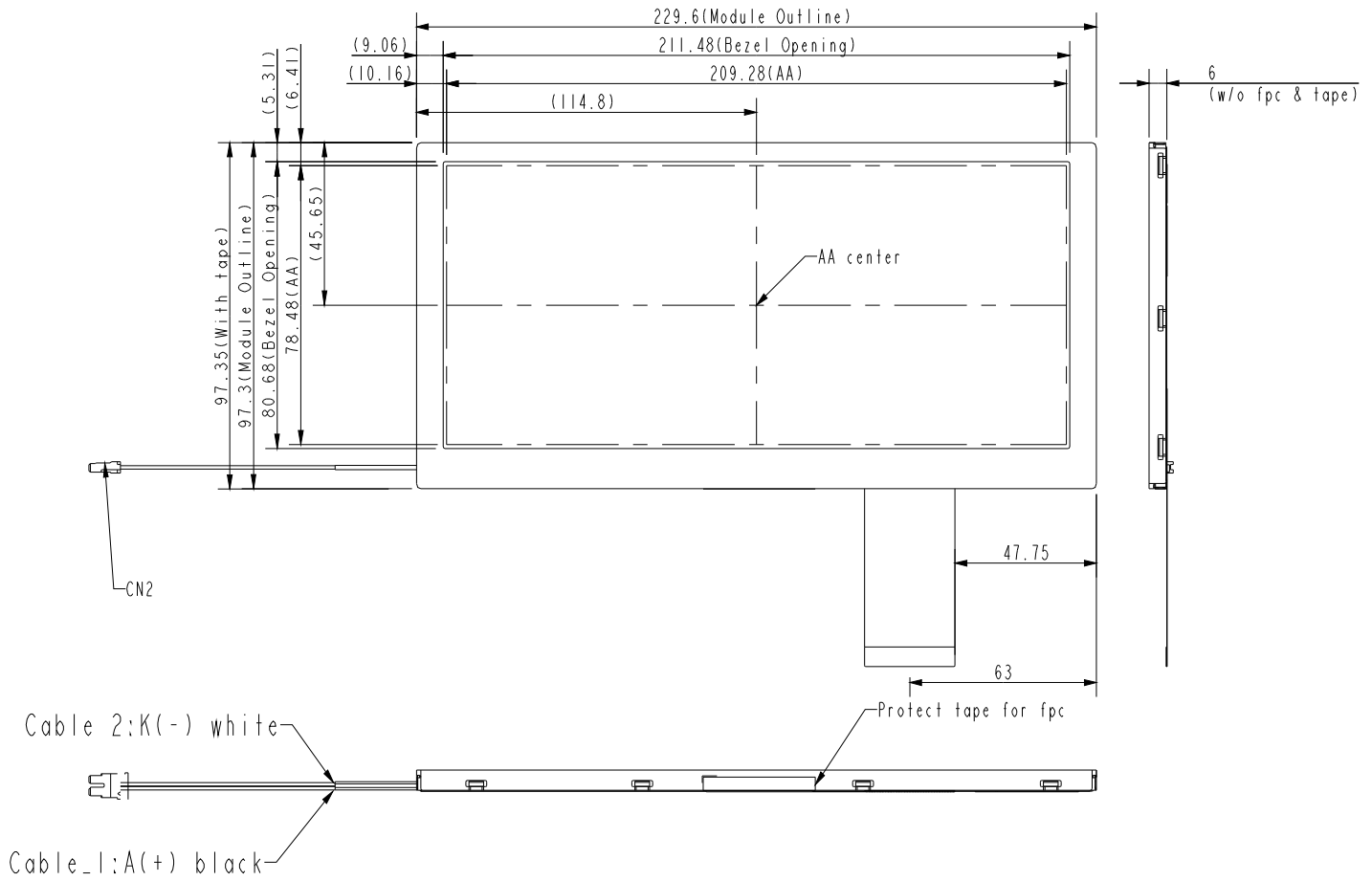

NOTE: General tolerance=±0.3mm

6.2 Rear Side

[Unit : mm]

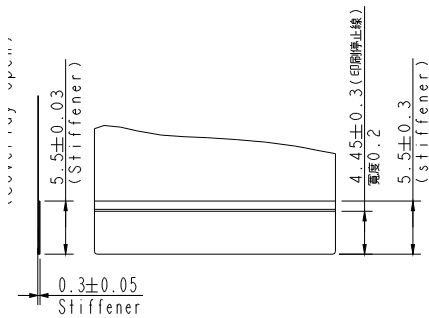
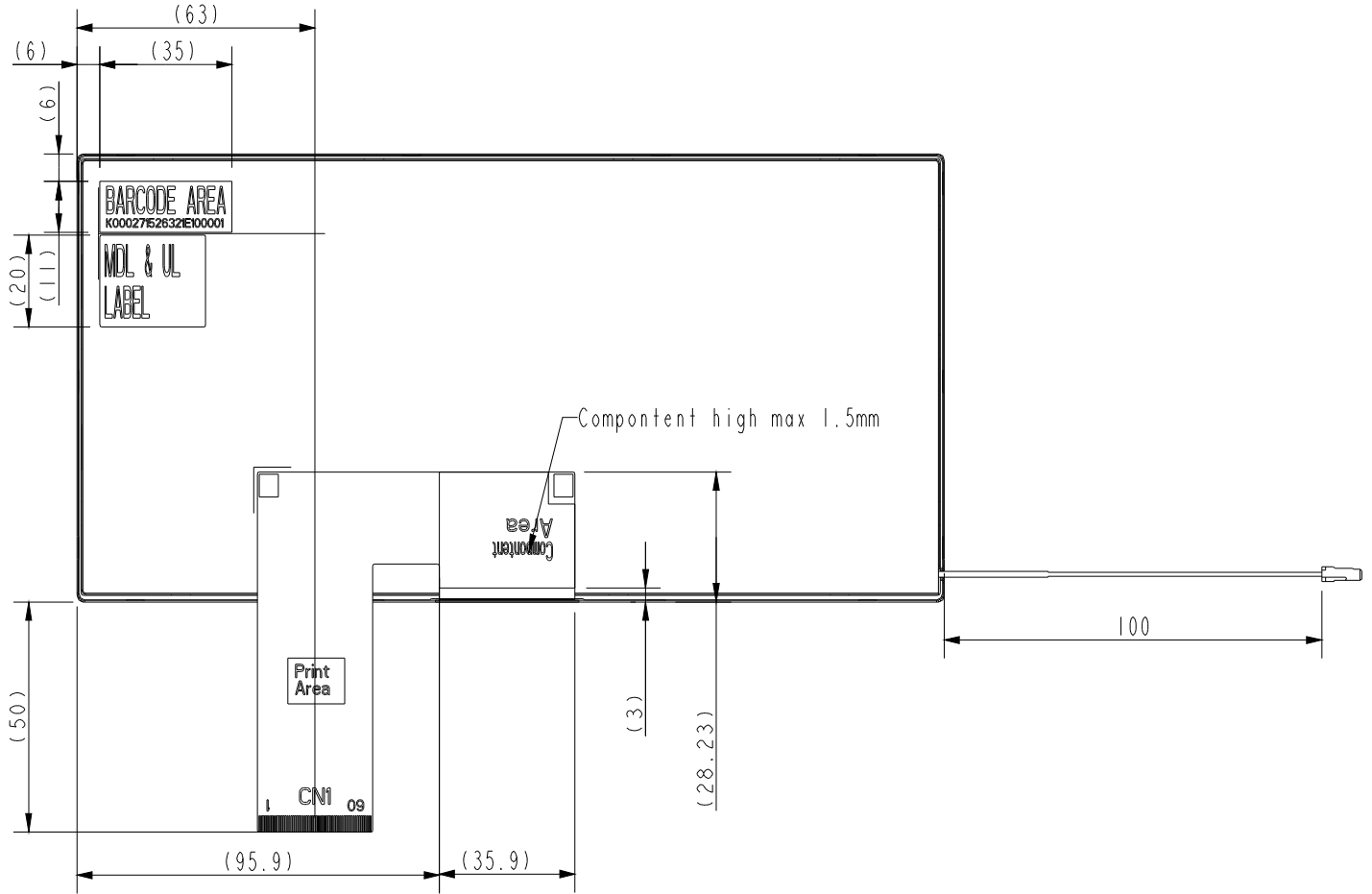

NOTE: General tolerance= $\pm 0.3$ mm  
 CN1 suggest connector (60pin):089K60-000100-G2-R (STARCONN)  
 CN2 suggest connector SM02B-BHSS-1(JST)



## 7. OPTICAL CHARACTERISTICS

Ta = 25°C, VCC=3.3V

ITEM	SYMBOL	CONDITIONS	MIN	TYP	MAX	UNIT	NOTE	
Contrast Ratio	CR	Point-5	600	1000		--	1, 2, 3	
Luminance(CEN)	Lw	Point-5	400	500		cd/m <sup>2</sup>	1, 3	
Luminance Uniformity	ΔL		70	85		%	1, 3	
Response Time (White - Black)	Tr +Tf	Point-5	-	25	35	ms	1, 3, 5	
NTSC	-	Point-5	60	70	-	%	1, 4	
Viewing Angle	Vertical	Upper( $\theta$ )	CR ≥ 10 Point-5	75	85	--	°	1, 4
		Down( $\theta$ )		75	85			1, 4
	Horizontal	Left( $\phi$ )		75	85			1, 4
		Right( $\phi$ )		75	85	--	°	1, 4
Color Coordinate	White	Wx Wy	Point-5	(0.250) (0.253)	(0.290) (0.293)	(0.330) (0.333)	--	1, 3
	Red	Rx Ry		(0.602) (0.304)	(0.642) (0.344)	(0.682) (0.384)		
	Green	Gx Gy		(0.280) (0.588)	(0.320) (0.628)	(0.360) (0.668)		
	Blue	Bx By		(0.106) (0.038)	(0.146) (0.078)	(0.186) (0.118)		

Note1: Measure condition : 25°C±2°C , 60±10%RH , under 1 Lux in the dark room color coordinate and color gamut are measured by SRUL1R,and all the other items are measured by BM-5A (TOPCON) , viewing angle 2° , IL=280mA ( Backlight current ) , measurement after lighting on 10 mins.

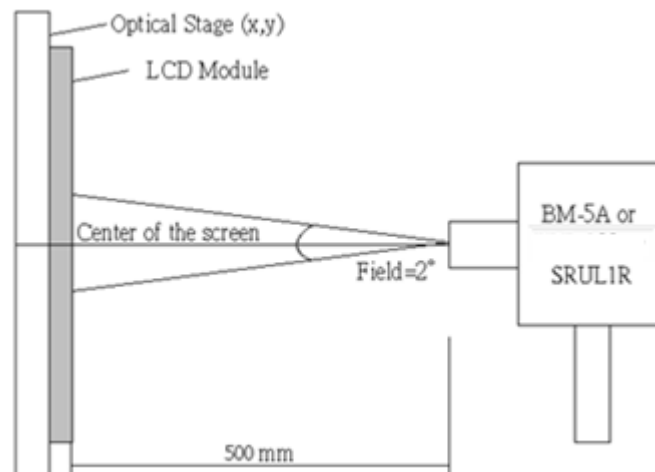

Note2: Definition of contrast ratio :

$$\text{Contrast Ratio (CR)} = (\text{White) Luminance of ON} \div (\text{Black) Luminance of OFF}$$

Note3: Definition of luminance : Measure white luminance on the point 5 as figure.7-1

Definition of Luminance Uniformity: Measure white luminance on the point1~9 as figure.7-1

$$\Delta L = [L(\text{MIN})/L(\text{MAX})] \times 100$$

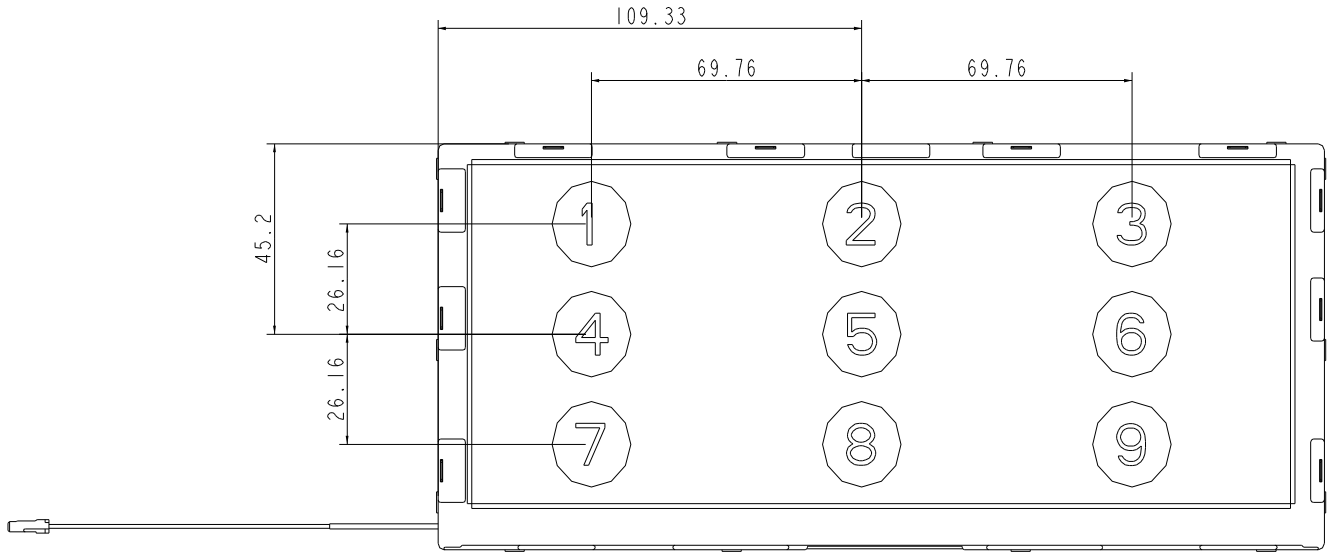

Fig.7-1 Measuring point

Note 4: Definition of Viewing Angle( $\theta, \psi$ ), refer to Fig.7-2 as below :

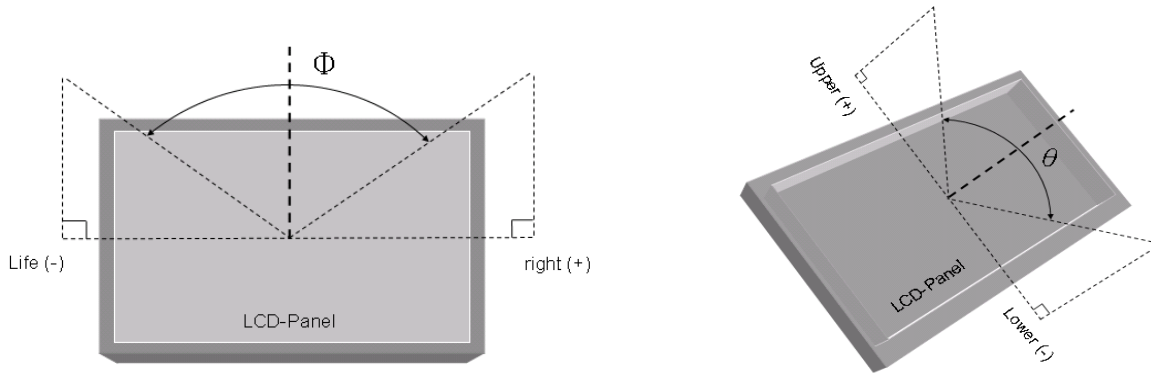

Fig.7-2 Definition of Viewing Angle

Note5: Definition of Response Time.(White-Black)

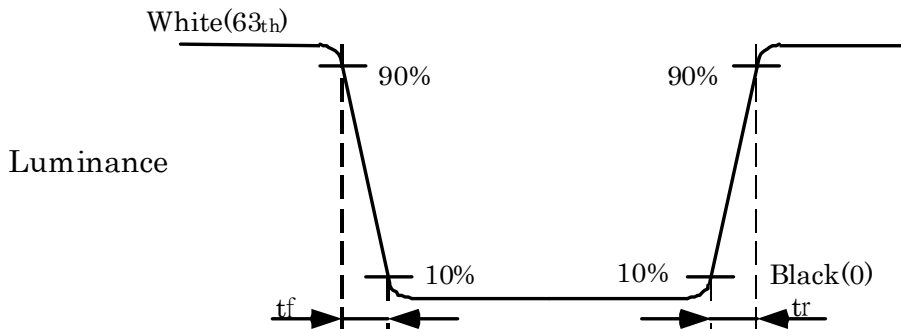

Fig.7-3 Definition of Response Time(White-Black)

## 8. RELIABILITY TEST

### 8.1. Temperature and humidity

TEST ITEMS	CONDITIONS	NOTE
High Temperature Operation	70°C ; 240hrs	
High Temperature Storage	80°C ; 240hrs	
High Temperature High Humidity Operation	60°C ; 90% RH ; 240hrs	No condensation
Low Temperature Operation	-20°C ; 240hrs	
Low Temperature Storage	-30°C ; 240hrs	
Thermal Shock	-30°C (0.5hr) ~ 80°C (0.5hr) ; 200 Cycles	
Image Sticking	25 °C ± 2 °C ; 2hrs	Note 1

Note 1. :

Condition of Image Sticking test : 25 °C ± 2 °C

Operation with test pattern sustained for 2 hrs, then change to gray pattern immediately.

After 5 mins, the mura must be disappeared completely .

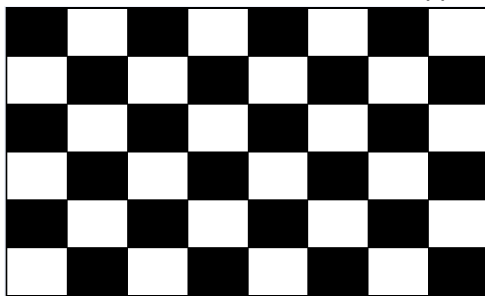

Image Sticking -pattern



Mid-Gray pattern

### 8.2. Shock and Vibration

TEST ITEMS	CONDITIONS
Shock (Non-operation)	<ul style="list-style-type: none"> <li>● Shock level: 980m/s<sup>2</sup>(equal to 100G).</li> <li>● Waveform: half sinusoidal wave,6ms.</li> <li>● Number of shocks: +X,+Y,+Z each axis 3 times</li> </ul>
Vibration (Non-operation)	<ul style="list-style-type: none"> <li>● Frequency range:8~33.3Hz</li> <li>● Stoke : 1.3 mm</li> <li>● Vibration: sinusoidal wave, perpendicular axis(both x, z axis: 2hrs ,y axis: 4hrs).</li> <li>● Sweep: 2.9G,33.3 Hz -400 Hz</li> <li>● Cycle time: 15 min</li> </ul>

### 8.3 Electrostatic Discharge

TEST ITEM	CONDITIONS	Note
ESD	150pF , 330Ω , ±8kV&±15kV air& contact test	1
	200pF , 0Ω , ±200V contact test	2

Note: Measure

1: LCD glass and metal bezel

2: IF connector pins

### 8.4. Judgment standard

The Judgment of the above test should be made as follow:

Pass:Normal display image with no line defect.

Fail: No display image, Function NG, or line defects.

## 9. WARRANTY

9.1 The period is within 12 months since the date of shipping out under normal using and storage conditions.

9.2 The warranty will be avoided in case of defect induced by customer